

Special-Purpose Electric Machines

- The machines introduced in this lecture are used in many applications requiring fractional horsepower, or the ability to accurately control position, velocity or torque. They include
 - Brushless DC Motors
 - Stepping Motors
 - Single Phase Motors
 - The Universal Motors
 - Single-Phase Induction Motors

Brushless DC Servomotor

A servo motor is a DC, AC, or brushless DC motor combined with a position sensing device (digital decoder). Servos are extremely useful in robotics. The motors are small and are extremely powerful for the size.

Brushless DC motor is not a DC motor but a permanent-magnet synchronous machine. The name is actually due to the fact that its operating characteristics resemble those of shunt DC motor with constant field current.

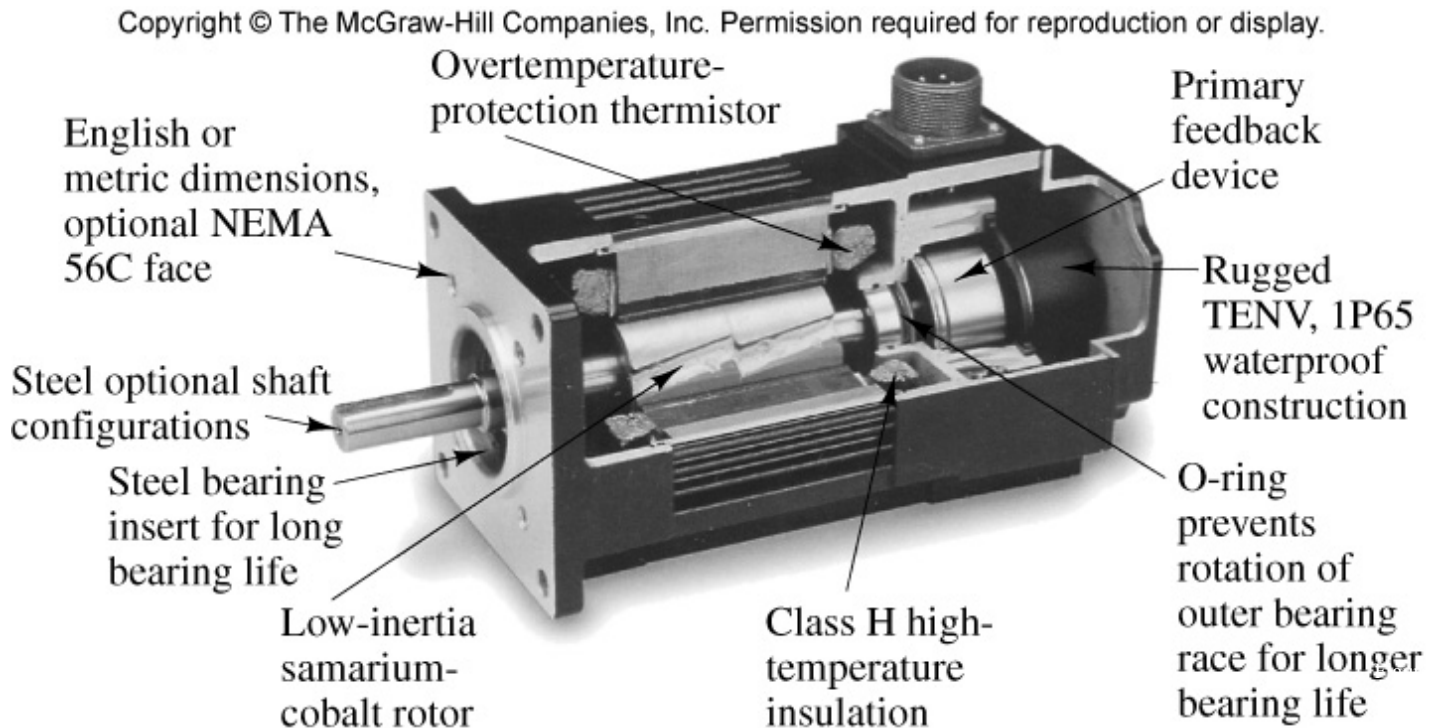

Transistor and SCR Drives for a Brushless DC Motor

Copyright © The McGraw-Hill Companies, Inc. Permission required for reproduction or display.

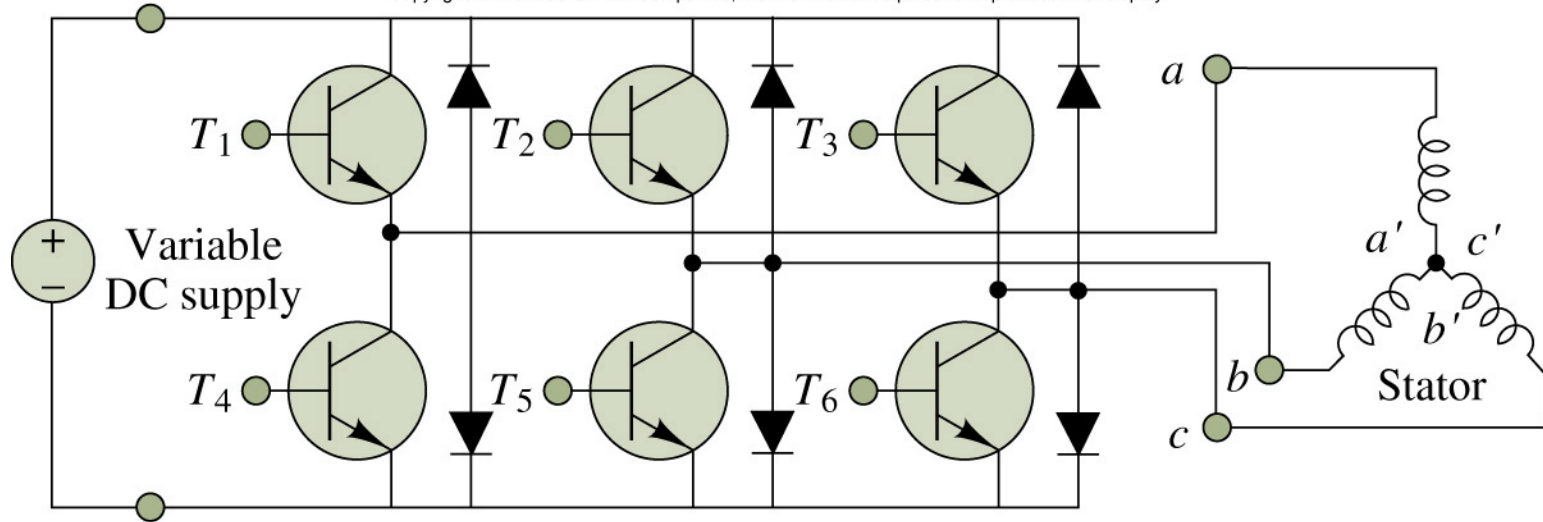

Transistor supply for brushless DC motor

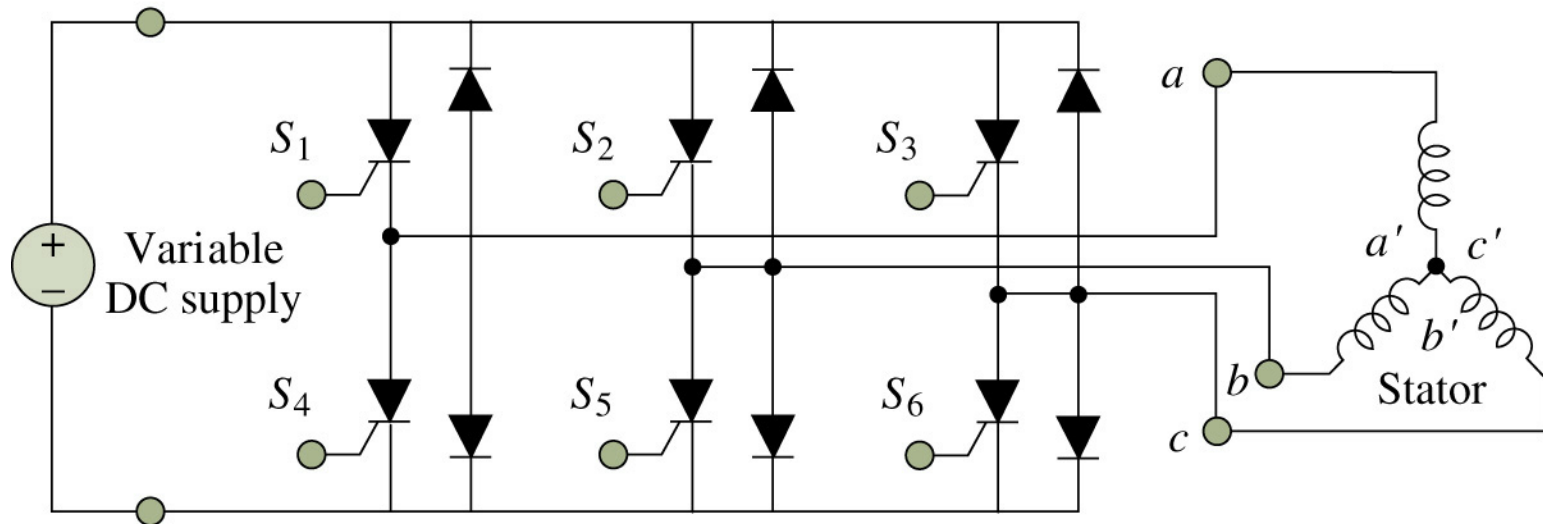

SCR supply for brushless DC motor

Stepping Motors

A special type of synchronous motor which is designed to rotate a specific number of degrees for every electric pulse received by its control unit. Typical steps are 7.5 or 15° per pulse. It is a motor that can rotate in both directions, move in precise angular increments, sustain a holding torque at zero speed, and be controlled with digital circuits. It moves in accurate angular increments known as steps, in response to the application of digital pulses to the electric drive circuit. Generally, such motors are manufactured with steps per revolution. Step motors are either bipolar, requiring two power sources or unipolar requiring only one power source.

$$\theta_m = \frac{2}{p} \theta_e$$

$$\omega_m = \frac{2}{p} \omega_e$$

Copyright © The McGraw-Hill Companies, Inc.
Permission required for reproduction or display.

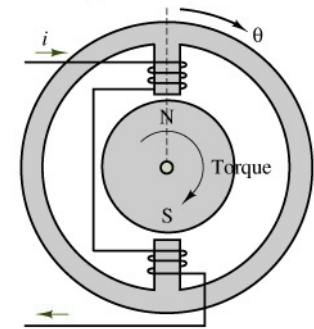

(a) Permanent-magnet stepping motor

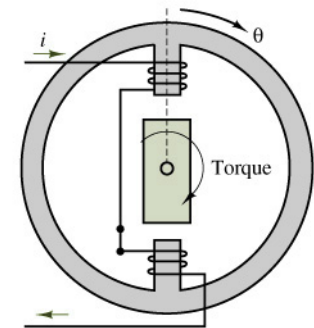

(b) Variable-reluctance stepping motor

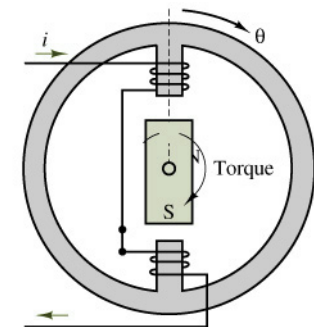

(c) Hybrid stepping motor

Variable Reactance (VR) Stepper Motor (a) Complete Motor Assembly; (b) PM Rotor; (c) Stator Cross Section; (d) Fully Assembled Stator; (e) Stator with Windings.

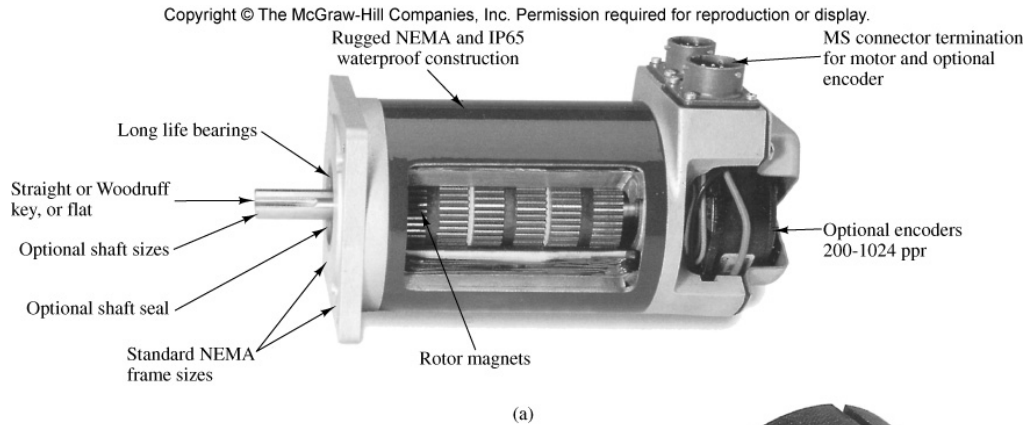

Copyright © The McGraw-Hill Companies, Inc. Permission required for reproduction or display.

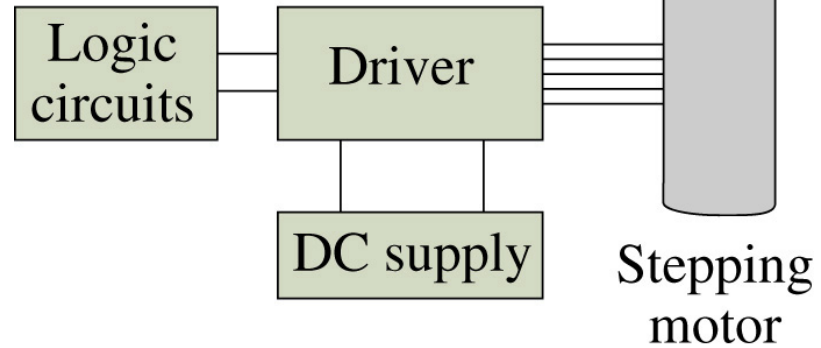

Universal Motor

The universal motor is a rotating machine similar to a DC motor but designed to operate either from DC or single-phase AC. The stator and rotor windings of the motor are connected in series through the rotor commutator. Therefore the universal motor is also known as an AC series motor or an AC commutator motor. The universal motor can be controlled either as a phase-angle drive or as a chopper drive.

The universal motor has a sharply drooping torque-speed characteristics of a DC series motor.

Typical applications in vacuum cleaners, drills, and kitchen appliances.

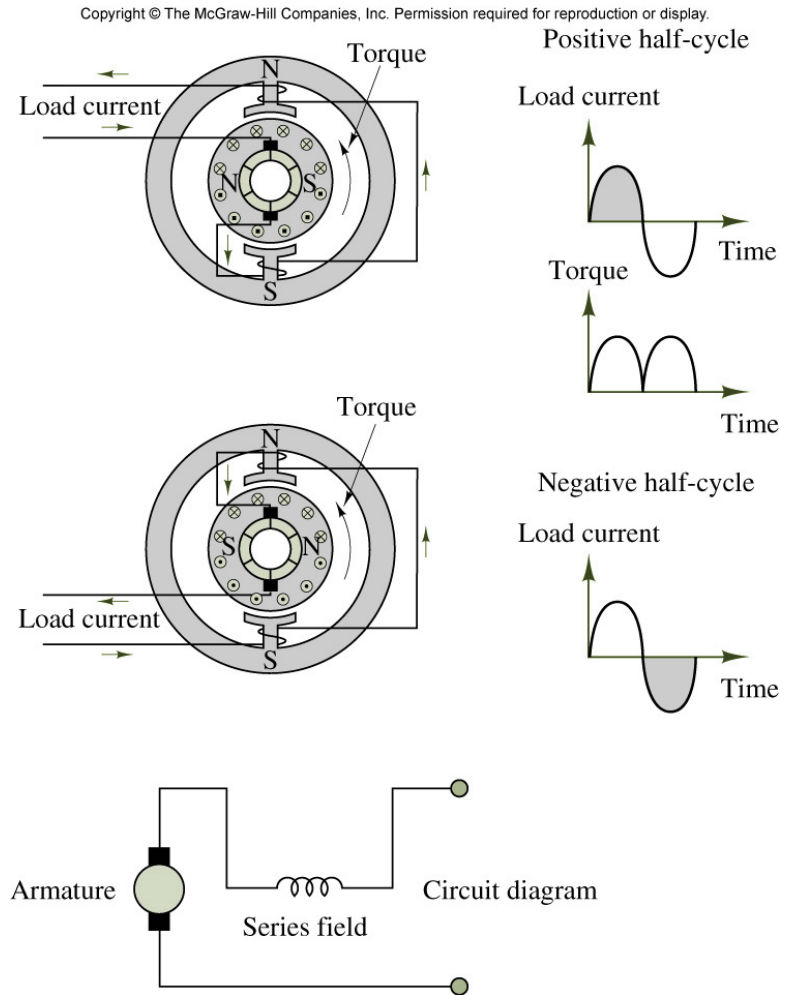

Single-Phase Induction Motor

There are several types of single-phase induction motors in use today. Basically they are identical except for the means of starting. They may be classified as: Split-phase motors; and capacitor-start motors

Copyright © The McGraw-Hill Companies, Inc. Permission required for reproduction or display.

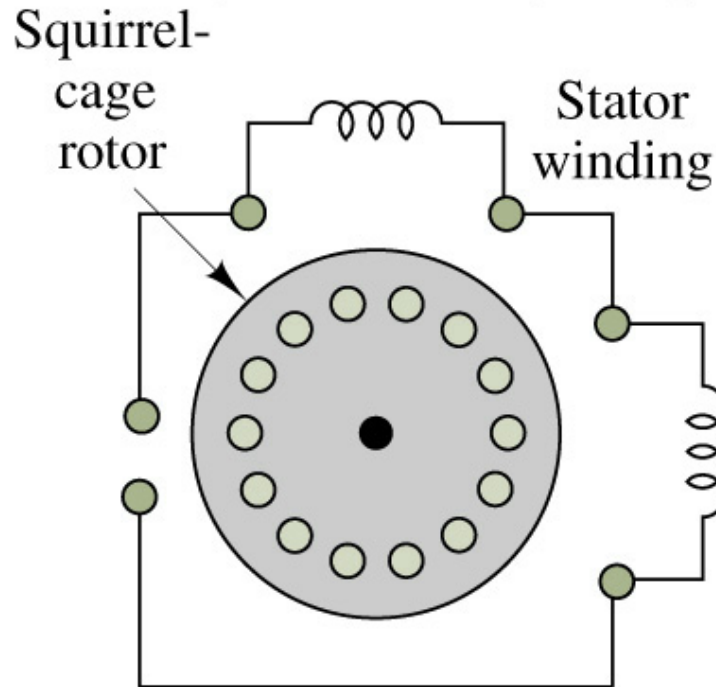

Split-Phase Motor

They are constructed with two-separate stator windings, called main and auxiliary windings. The axes of the two windings are 90° with respect to each other. The auxiliary winding current is out of phase with the main winding current, as a result of the different reactances of the two windings. Once the motor started, centrifugal switch is used to disconnect the auxiliary winding. This motor is used for fans, blowers, centrifugal pumps (range 1/20 to 1/2 hp)

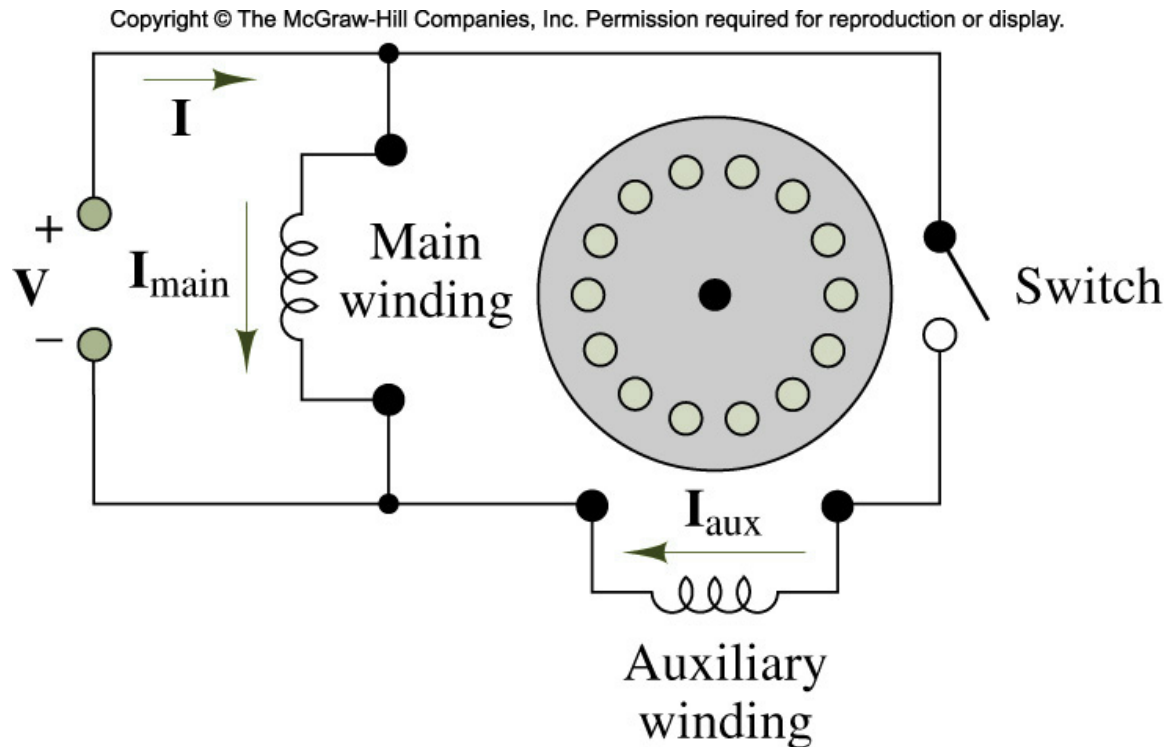

Capacitor-Start Motor

Another method to obtain a phase difference between two current that will give rise to a rotating magnetic field is by addition of a capacitor in series with the auxiliary winding. The addition of the capacitor changes the reactance of the auxiliary current in order to lead the main current. So the starting torque will be higher. Once the motor started, centrifugal switch is used to disconnect the auxiliary winding.

Copyright © The McGraw-Hill Companies, Inc. Permission required for reproduction or display.

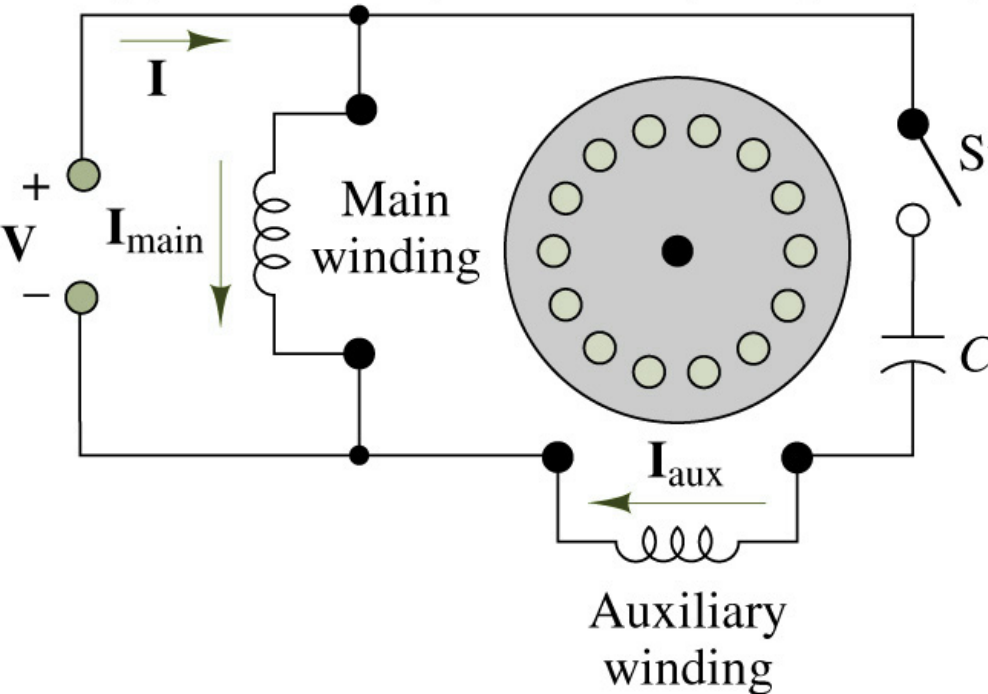

Copyright © The McGraw-Hill Companies, Inc. Permission required for reproduction or display.

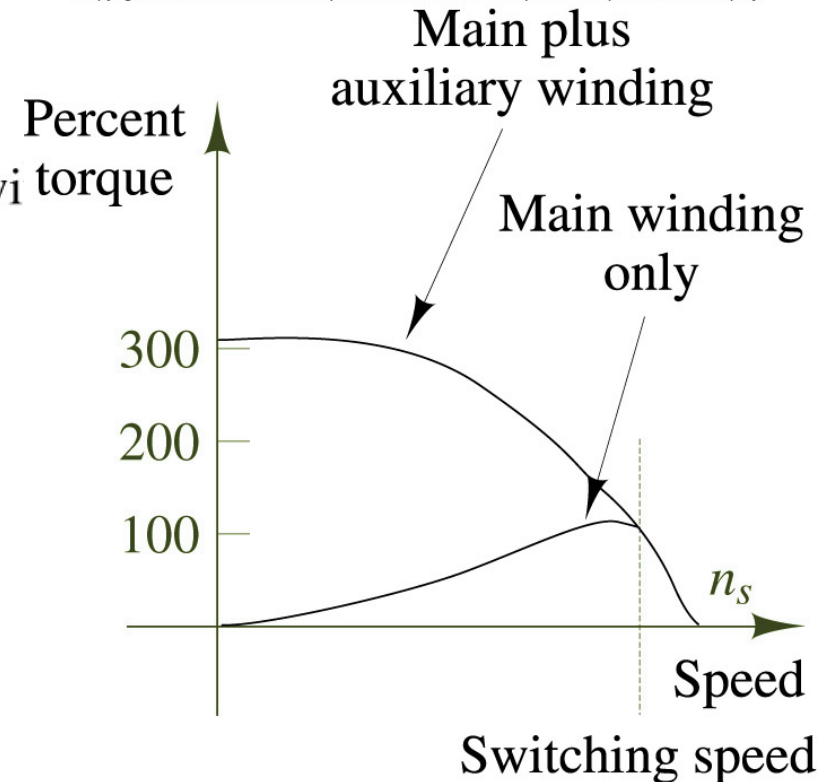

Capacitor-Start Capacitor-Run Motor

By using two capacitors—one to obtain a permanent phase split and the resulting improvement in running characteristics, the other capacitor (larger) will improve the starting torque.

Copyright © The McGraw-Hill Companies, Inc. Permission required for reproduction or display.

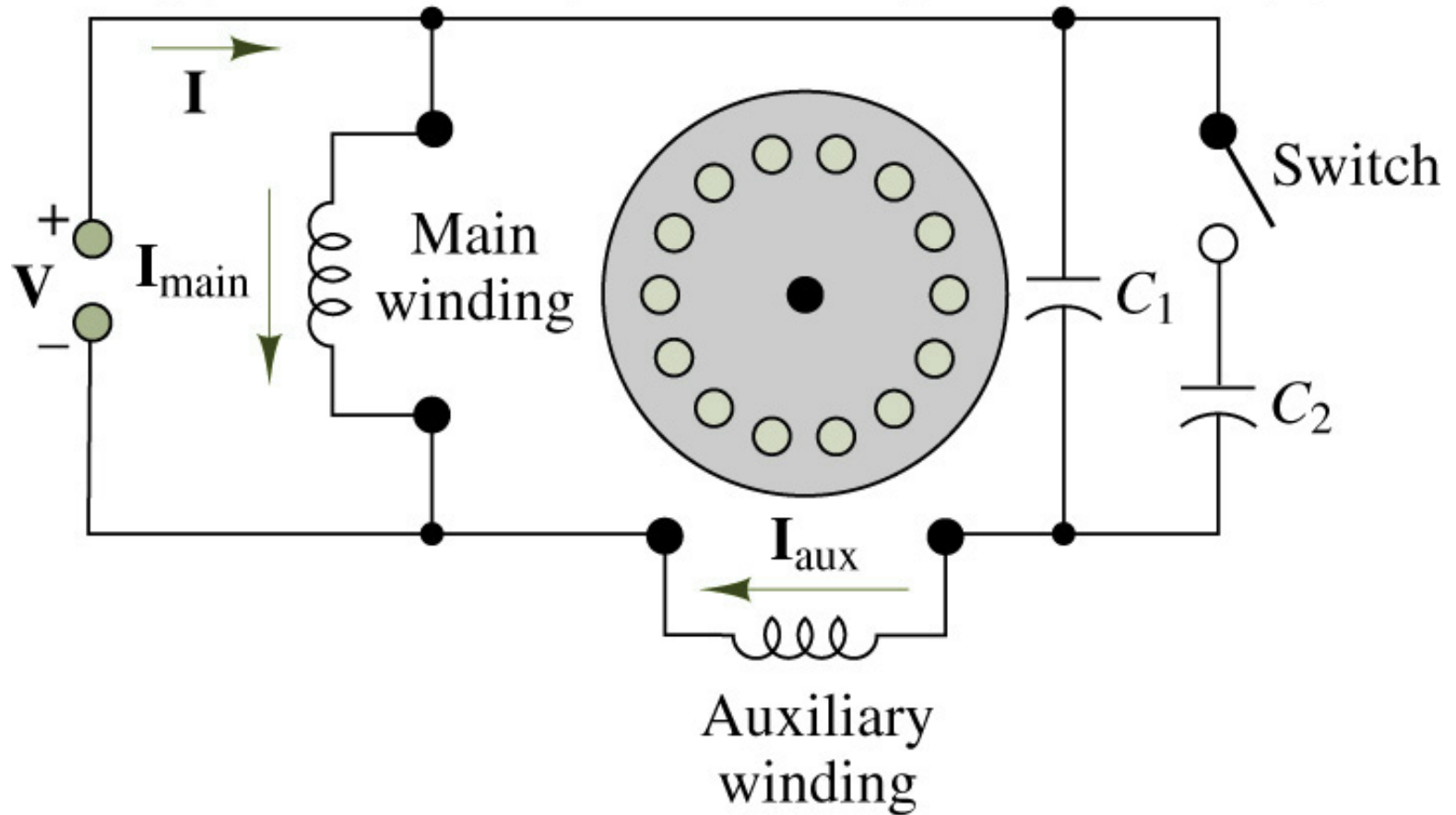

Motor Selection Criteria

- Available power (DC or AC)
- Operating condition.
- Starting characteristics (torque and current)
- Operating speed.
- Forward/reverse operation.
- Acceleration characteristics (depending on load)
- Efficiency at rated load.
- Overload capability.
- Electrical and thermal safety.
- Life span and maintenance.
- Mechanical aspects (size, weight, noise level, environment).
- EMC and EMI
- Control complexity and Cost.